

JH. Living Vocoder
 (c) J. Haible 2010
 All Rights reserved
 Errors excepted
 Channel 16

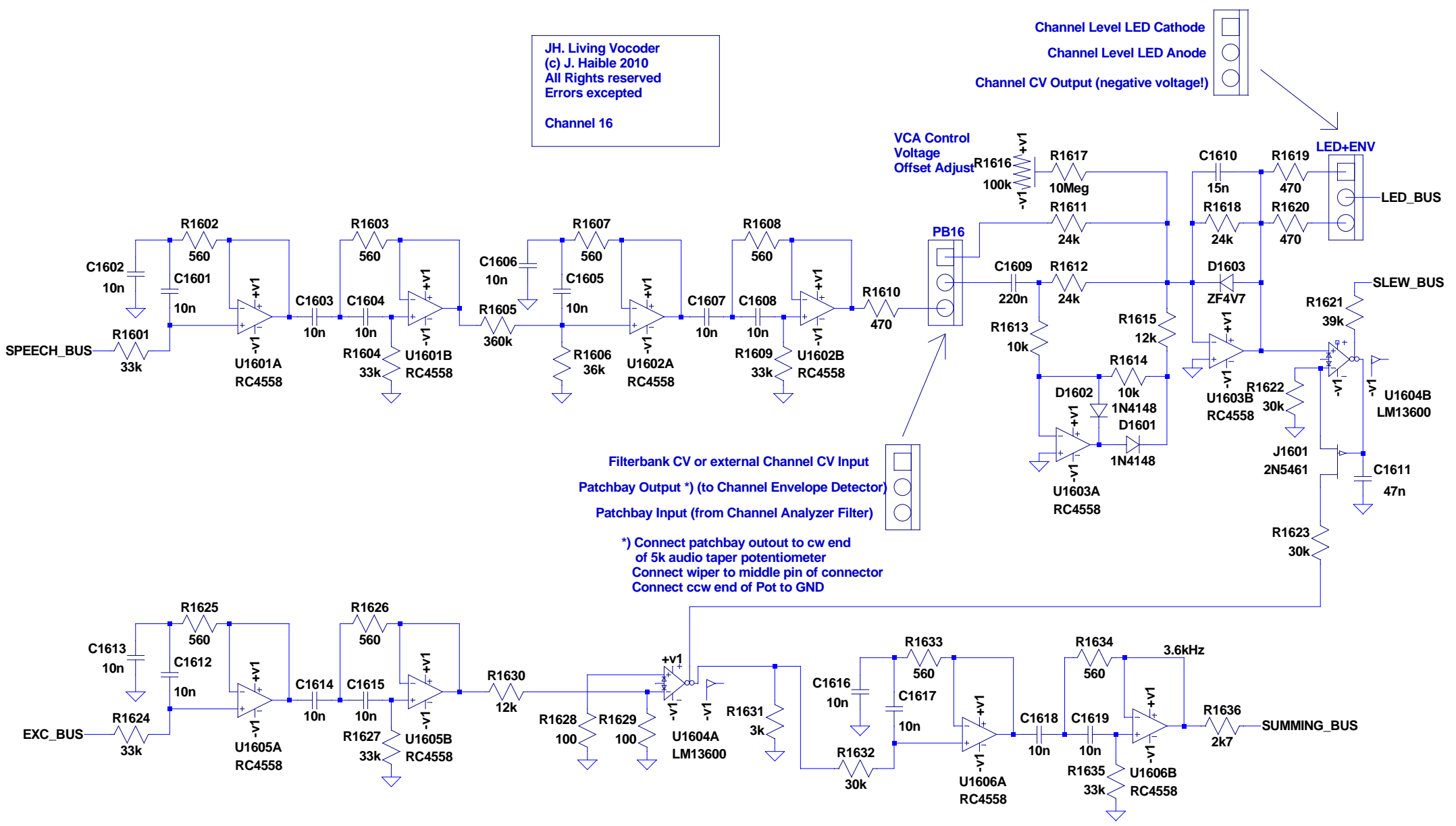

Channel Level LED Cathode
 Channel Level LED Anode
 Channel CV Output (negative voltage!)

Filterbank CV or external Channel CV Input
 Patchbay Output *) (to Channel Envelope Detector)
 Patchbay Input (from Channel Analyzer Filter)

*) Connect patchbay output to cw end of 5k audio taper potentiometer
 Connect wiper to middle pin of connector
 Connect ccw end of Pot to GND